

RECEPTION DESKS SYSTEMS

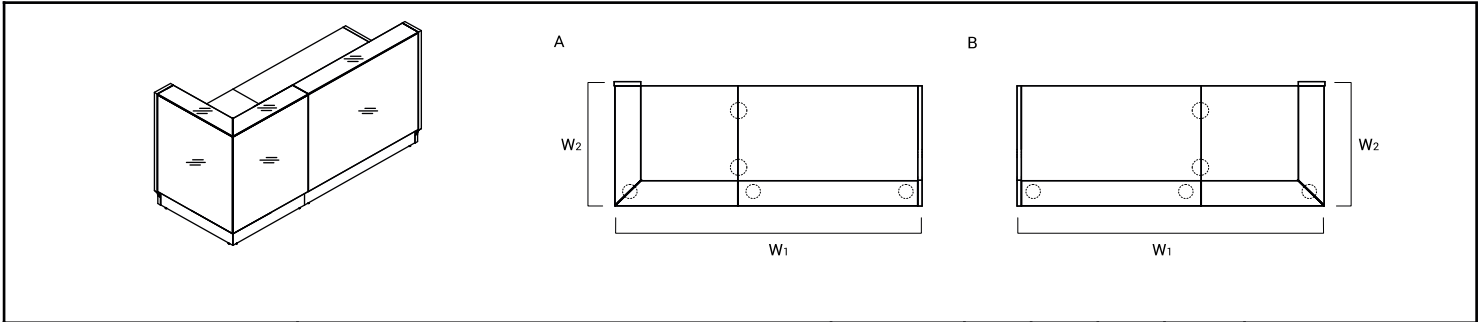

INDEX SYMBOL	DIMENSIONS [mm]						kg	m3	pcs	COMMENTS
	W ₁	W ₂	D ₁	D ₂	H					
A LIN38L	2050	850			1105		178.0	1.560	10	LN5L+LNB13+LN12+LNB08+LN91+LN3P+NL41
B LIN38P	2050	850			1105		178.0	1.560	10	LN3L+LNB08+LN91+LNB13+LN12+LN5P+NL41

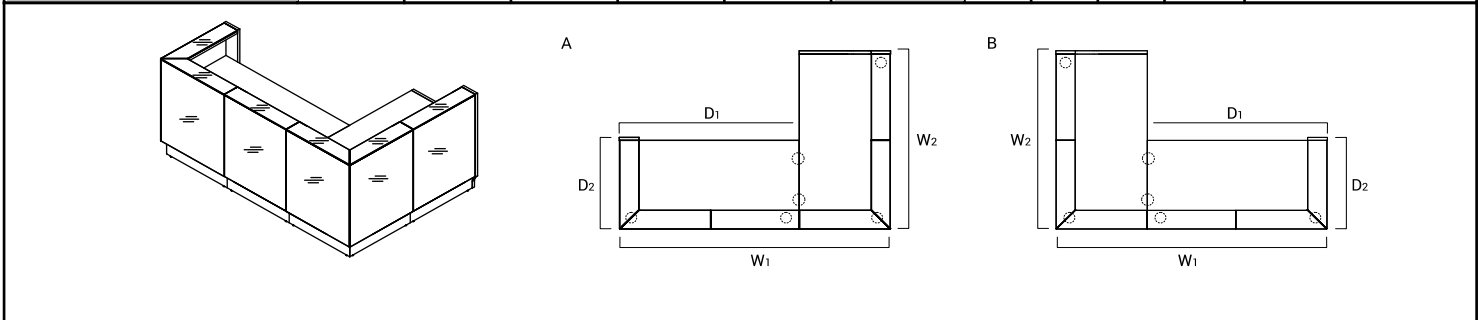

INDEX SYMBOL	DIMENSIONS [mm]						kg	m3	pcs	COMMENTS
	W ₁	W ₂	D ₁	D ₂	H					
A LIN39L	2444	1650	1622	850	1105		286.0	2.735	14	LN5L+2xLN08+2xLNB15+2xLN91+LN3P+NL41
B LIN39P	2444	1650	1622	850	1105		292.0	2.746	16	LN3L+2xLN91+2xLNB15+2xLN08+LN5P+NL41

ADDITIONAL CHARGE

FEATURE	PRODUCT								kg	m3	pcs	COMMENTS
	LIN38L	LIN38P	LIN39L	LIN39P								
MONITOR SHELF x 1									0.1	0.0001	1	
MONITOR SHELF x 2									0.9	0.0070	1	

DESCRIPTION

- NET WEIGHT

VOLUME

NUMBER OF PACKAGES

RECEPTION DESKS SYSTEMS

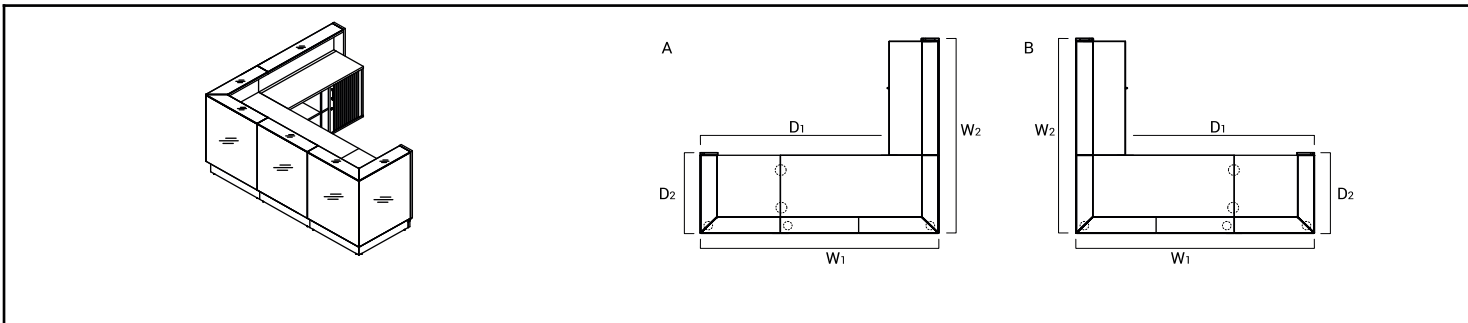

INDEX SYMBOL	DIMENSIONS [mm]					kg	m3	pcs	COMONENTS
	W ₁	W ₂	D ₁	D ₂	H				
A LIN40L	2444	2050	1950	850	1105	332.5	3.283	16	LN3L+LN12+L2Z06+2xLN91+LNB15+LN08+LNB08+LN3P+NL41
B LIN40P	2444	2050	1950	850	1105	332.5	3.283	16	LN3L+LNB08+2xLN91+LN08+LNB15+L2Z06+LN12+LN3P+NL41

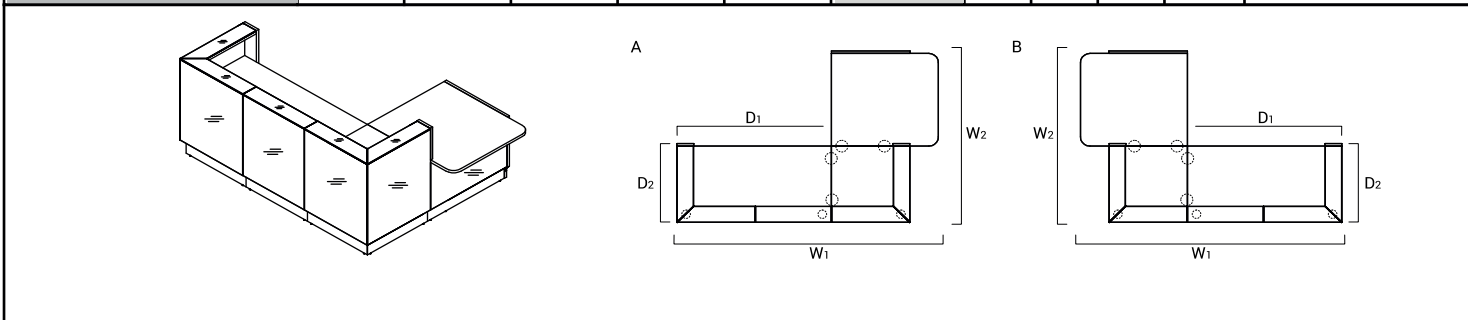

INDEX SYMBOL	DIMENSIONS [mm]					kg	m3	pcs	COMONENTS
	W ₁	W ₂	D ₁	D ₂	H				
A LIN41L	2744	1850	1622	850	1105	282.5	2.674	16	LN6L+LNU11+LN4L+2xLN91+LNB08+LN08+LNB15+LN3P+2xNL41
B LIN41P	2744	1850	1622	850	1105	282.5	2.672	16	LN3L+2xLN91+LNB15+LN08+LNB08+LN4P+LNU11+LN6P+2xNL41
A LIN411L	2544	1850	1622	850	1105	277.5	2.648	16	LN6L+LNU11+LN4L+2xLN91+LNB08+LN08+LNB15+LN3P+2xNL41
B LIN411P	2544	1850	1622	850	1105	277.5	2.645	16	LN3L+2xLN91+LNB15+LN08+LNB08+LN4P+LNU11+LN6P+2xNL41

ADDITIONAL CHARGE



FEATURE	PRODUCT							kg	m3	pcs	COMMENTS
	LIN40L	LIN40P	LIN41L	LIN41P	LIN411L	LIN411P					
MONITOR SHELF x 1								0.1	0.0001	1	

DESCRIPTION





- NET WEIGHT

VOLUME

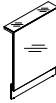

NUMBER OF PACKAGES

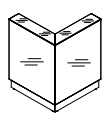
PRODUCT ILLUSTRATION	DIMENSIONS [mm]			INDEX SYMBOL						COMMENTS
	WIDTH	DEPTH	HEIGHT			kg	m3	pcs		

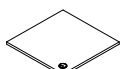
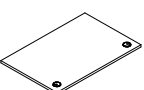
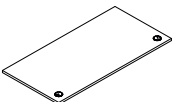
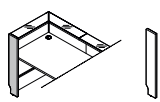
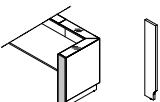
COMPOSITION ELEMENTS

	800	250	1105	LN08		27.5	0.254	2		
	1200	250	1105	LN12		41.5	0.376	2		
	822	822	1105	LN91		78.5	1.007	2		
	800	1122	740	LNU111		26.5	0.129	2		
	1000	1122	740	LNU11		31.5	0.156	2		
	800	800	28	LNB08		14.0	0.025	1		
	1200	800	28	LNB13		21.0	0.042	2		
	1600	800	28	LNB15		27.0	0.054	2		
	254	28	1105	LN3L		7.0	0.014	1		left
	254	28	1105	LN3P		7.0	0.014	1		right

ADDITIONAL CHARGE



FEATURE	PRODUCT										COMMENTS
						LNB13	LNB15	kg	m3	pcs	
MONITOR SHELF x 1								0.1	0.0001	1	

DESCRIPTION







 - NET WEIGHT

 VOLUME

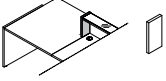
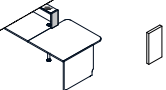
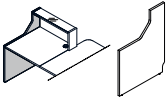
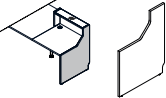
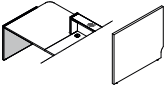
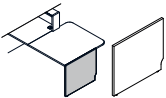
 NUMBER OF PACKAGES

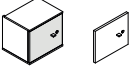
PRODUCT ILLUSTRATION	DIMENSIONS [mm]			INDEX SYMBOL						COMMENTS
	WIDTH	DEPTH	HEIGHT			kg	m3	pcs		

COMPOSITION ELEMENTS

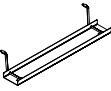
	254	28	367	LN4L		2.5	0.006	1		left
	254	28	367	LN4P		2.5	0.006	1		right
	824	28	1105	LN5L		14.0	0.033	1		left
	824	28	1105	LN5P		14.0	0.033	1		right
	824	28	740	LN6L		12.0	0.024	1		left
	824	28	740	LN6P		12.0	0.022	1		right
	345	283	314	LMS05		5.0	0.031	1		
	339	18	286	LMS06		2.0	0.005	1		
	1200	532	740	L2Z06		49.5	0.469	2		
	585	142	712	NL41		2.0	0.063	1		round profile leg
	580	162	123	S69L		1.0	0.015	1		09 - aluminum
	460	89	120	E64L		0.5	0.001	1		horizontal cable tray M009 - aluminum semi - matte

DESCRIPTION

 - NET WEIGHT

 VOLUME

 NUMBER OF PACKAGES